

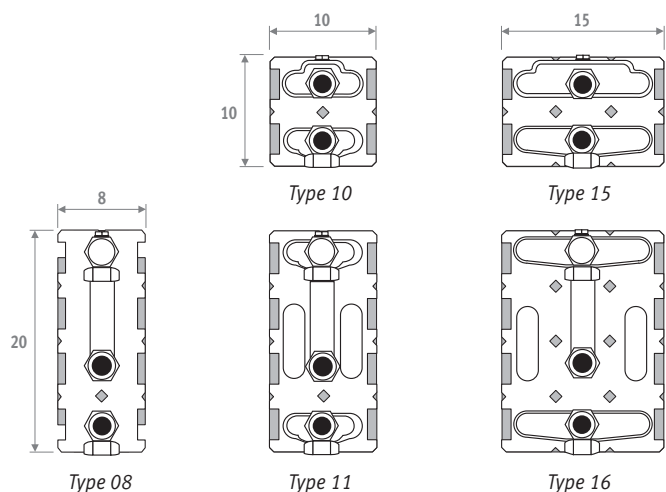

jaga

KNOCKONWOOD
Technische informatie

KNOCKONWOOD ■ OVERZICHT WARMTEWISSELAARS



Gewicht en waterinhoud zonder verpakking of opties.

GEWICHT IN KG/METER

Type	H 30	55	80
06	8.3	12.3	17.4
10	7.8	12.0	16.9
11	9.9	13.6	18.6
15	8.9	14.1	18.6
16	12.2	19.7	21.1

WATERINHOUD IN LITER / METER

Type	Alle hoogtes
08	0.63
10	0.65
11	1.33
15	0.98
16	1.98
20	1.32
21	2.66

CORRECTIEFACTOREN ■ KNOCKONWOOD

GEMIDDELDE CORRECTIEFACTOREN VOLGENS EN442 - 75/65/20°C

Tv	Tl	Tr	25	30	35	40	45	50	55	60	65	70	75	80	85
90	18		0.45	0.58	0.69	0.79	0.89	0.98	1.07	1.16	1.24	1.34	1.41	1.49	1.56
	20		0.38	0.52	0.63	0.74	0.83	0.92	1.01	1.10	1.18	1.28	1.35	1.43	1.50
	22		0.30	0.46	0.57	0.68	0.78	0.87	0.96	1.04	1.13	1.22	1.30	1.37	1.44
	24		0.20	0.39	0.52	0.62	0.72	0.81	0.90	0.99	1.07	1.15	1.24	1.31	1.38
85	18		0.42	0.54	0.65	0.75	0.84	0.93	1.01	1.10	1.20	1.27	1.34	1.41	
	20		0.36	0.49	0.59	0.69	0.79	0.87	0.96	1.04	1.12	1.21	1.28	1.35	
	22		0.28	0.42	0.54	0.64	0.73	0.82	0.90	0.99	1.06	1.15	1.22	1.30	
	24		0.19	0.36	0.48	0.58	0.68	0.76	0.85	0.93	1.01	1.10	1.17	1.24	
80	18		0.39	0.51	0.61	0.70	0.79	0.88	0.96	1.04	1.12	1.20	1.27		
	20		0.33	0.45	0.56	0.65	0.74	0.82	0.90	0.98	1.07	1.14	1.21		
	22		0.26	0.39	0.50	0.60	0.68	0.77	0.85	0.93	1.01	1.08	1.15		
	24		0.17	0.34	0.45	0.54	0.63	0.72	0.80	0.87	0.96	1.03	1.10		
75	18		0.37	0.47	0.57	0.66	0.74	0.82	0.90	0.99	1.05	1.12			
	20		0.30	0.42	0.52	0.61	0.69	0.77	0.85	0.93	1.00	1.07			
	22		0.24	0.36	0.46	0.55	0.64	0.72	0.79	0.88	0.95	1.01			
	24		0.16	0.31	0.41	0.50	0.59	0.67	0.74	0.83	0.89	0.96			
70	18		0.34	0.44	0.53	0.61	0.69	0.77	0.85	0.92	0.99				
	20		0.28	0.39	0.48	0.56	0.64	0.72	0.80	0.87	0.93				
	22		0.22	0.33	0.43	0.51	0.59	0.67	0.74	0.81	0.88				
	24		0.14	0.28	0.38	0.46	0.54	0.62	0.69	0.76	0.83				
65	18		0.31	0.40	0.49	0.57	0.64	0.71	0.79	0.85					
	20		0.25	0.35	0.44	0.52	0.59	0.66	0.74	0.80					
	22		0.19	0.30	0.39	0.47	0.54	0.61	0.69	0.75					
	24		0.12	0.25	0.34	0.42	0.50	0.57	0.64	0.70					
60	18		0.28	0.37	0.45	0.52	0.59	0.66	0.73						
	20		0.23	0.32	0.40	0.47	0.54	0.62	0.68						
	22		0.17	0.27	0.35	0.43	0.50	0.57	0.63						
	24		0.11	0.23	0.31	0.38	0.45	0.52	0.58						
55	18		0.25	0.33	0.40	0.47	0.55	0.60							
	20		0.20	0.29	0.36	0.43	0.50	0.56							
	22		0.15	0.24	0.32	0.38	0.45	0.51							
	24		0.09	0.20	0.27	0.34	0.40	0.47							
50	18		0.22	0.30	0.36	0.43	0.49								
	20		0.18	0.25	0.32	0.38	0.44								
	22		0.13	0.21	0.28	0.34	0.40								
	24		0.08	0.17	0.24	0.30	0.36								
45	18		0.19	0.26	0.32	0.38									
	20		0.15	0.22	0.28	0.34									
	22		0.11	0.18	0.24	0.30									
	24		0.06	0.14	0.20	0.26									
40	18		0.16	0.22	0.28										
	20		0.12	0.18	0.24										
	22		0.09	0.15	0.20										
	24		0.05	0.12	0.17										
35	18		0.13	0.19											
	20		0.10	0.15											
	22		0.07	0.12											
	24		0.03	0.09											
30	18		0.10												
	20		0.07												
	22		0.04												
	24		0.02												

De opgegeven vermogens bij ΔT 50 en ΔT 30 zijn exacte waardes. ΔT 50 gemeten volgens EN 442. ΔT 30 berekend volgens EN 442. Voor alle andere ΔT geeft deze tabel een gemiddelde correctiefactor geldig voor alle afmetingen.

KNOCKONWOOD - DRUKVERLIEZEN

DRUKVERLIES TYPE 08

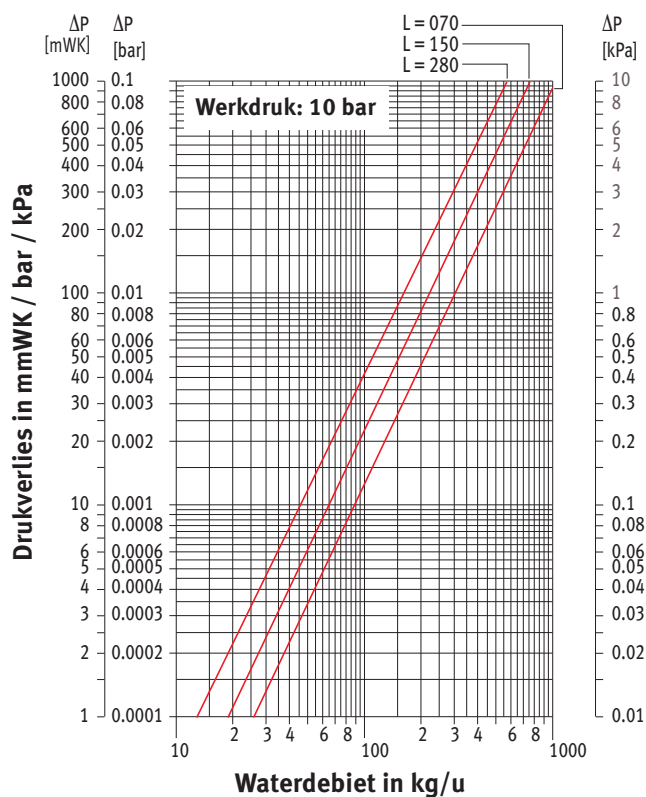

DRUKVERLIES TYPE 10

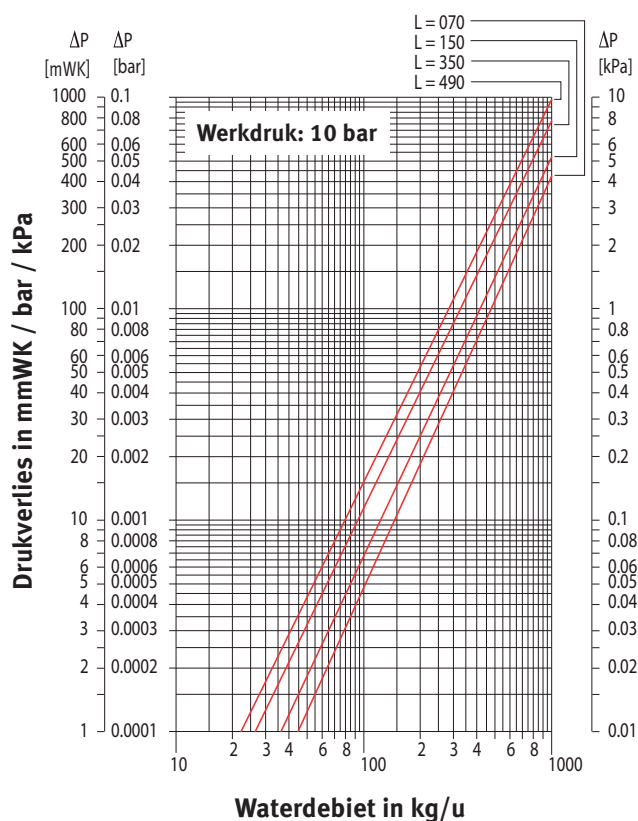

DRUKVERLIES TYPE 11

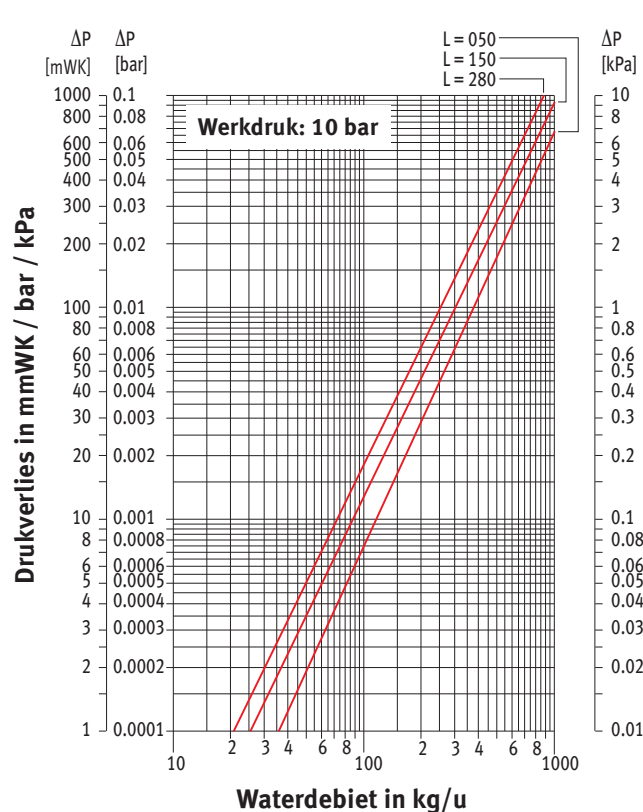

KNOCKONWOOD ▪ DRUKVERLIEZEN

DRUKVERLIES TYPE 15

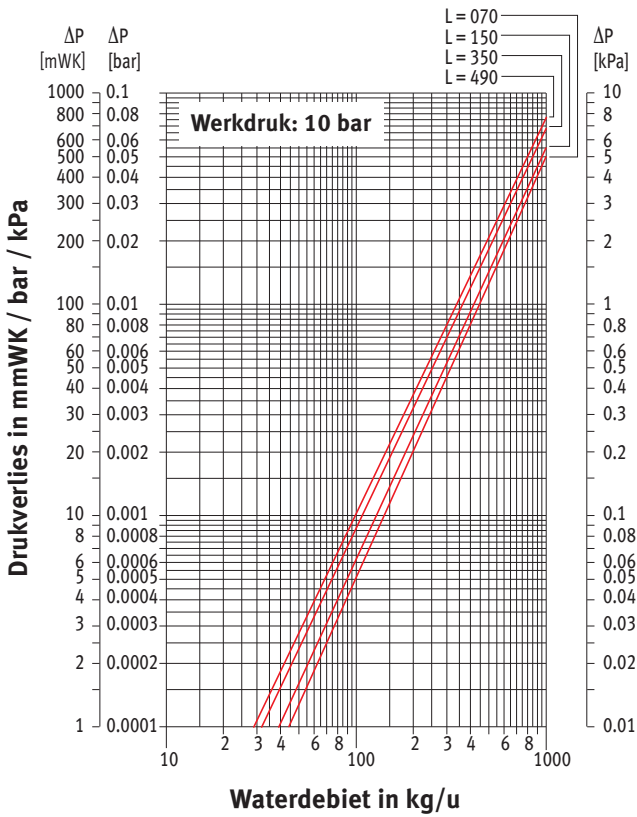

DRUKVERLIES TYPE 16

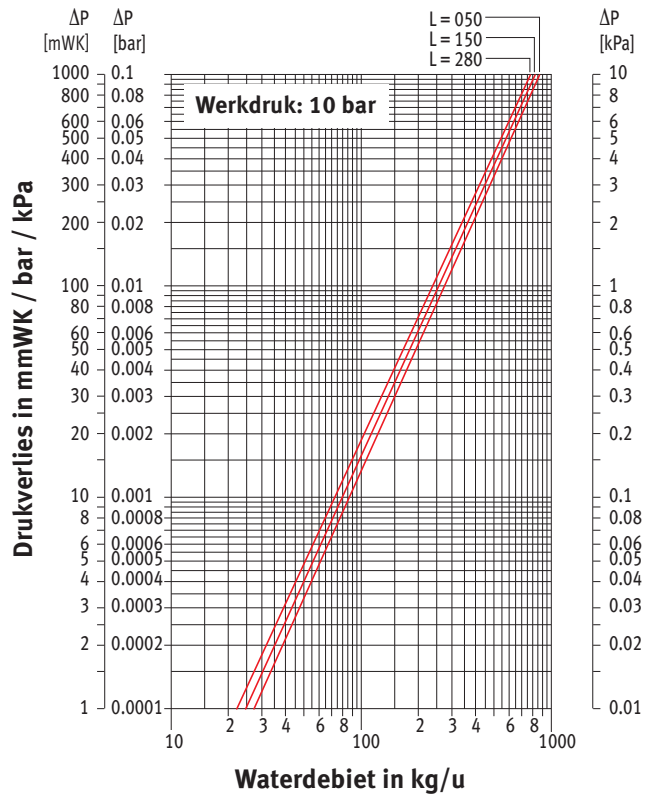

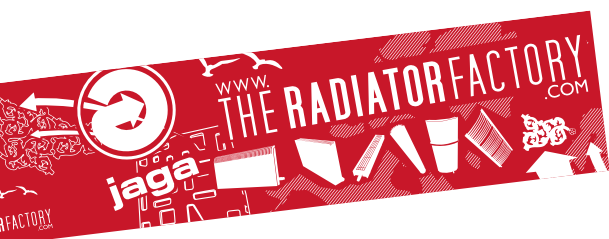

Jaga N.V.
Verbindingslaan 16
B-3590 Diepenbeek

Tel.: +32 (0)11 29 41 11
Fax: +32 (0)11 32 35 78
E-mail: info@jaga.be

Aangezien productontwikkeling een continu proces is, zijn alle
vermelde gegevens onder voorbehoud van wijzigingen.